

SUPERLANGEVIN

La Soda + Erwan Bonduelle Architecture



La Grâce de Dieu à Caen, un quartier prioritaire de la ville





Le bâtiment existant



Le bâtiment existant

Anatomie du Langevin

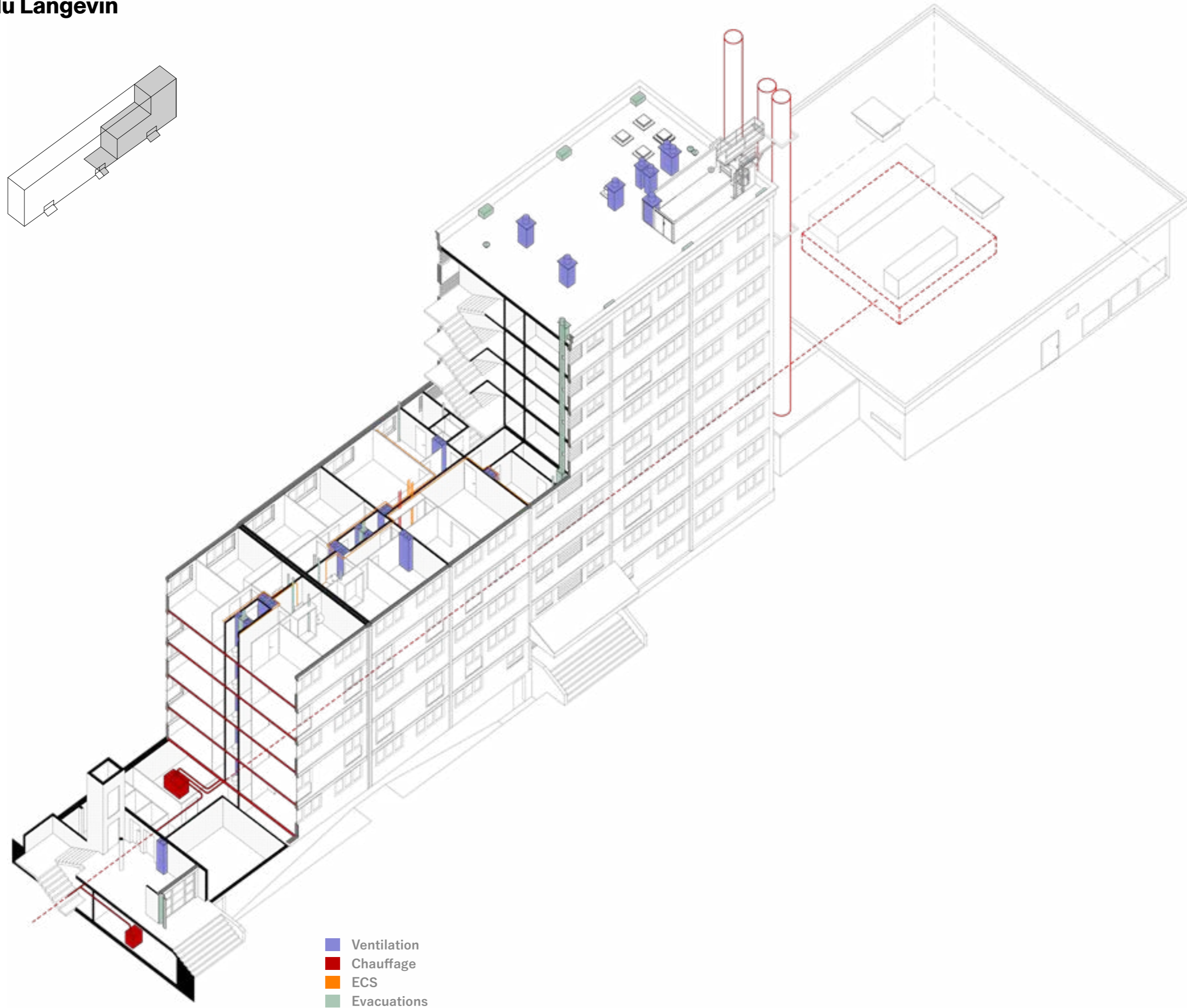
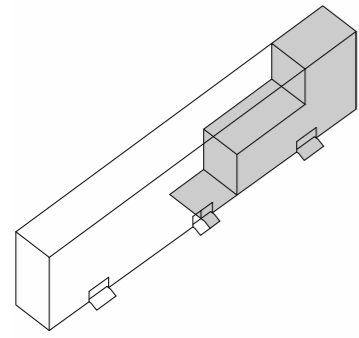

- Ventilation
- Chauffage
- ECS
- Evacuations

SuperLangevin, un immeuble pluriel



Plan RDC





Maison du Vivant

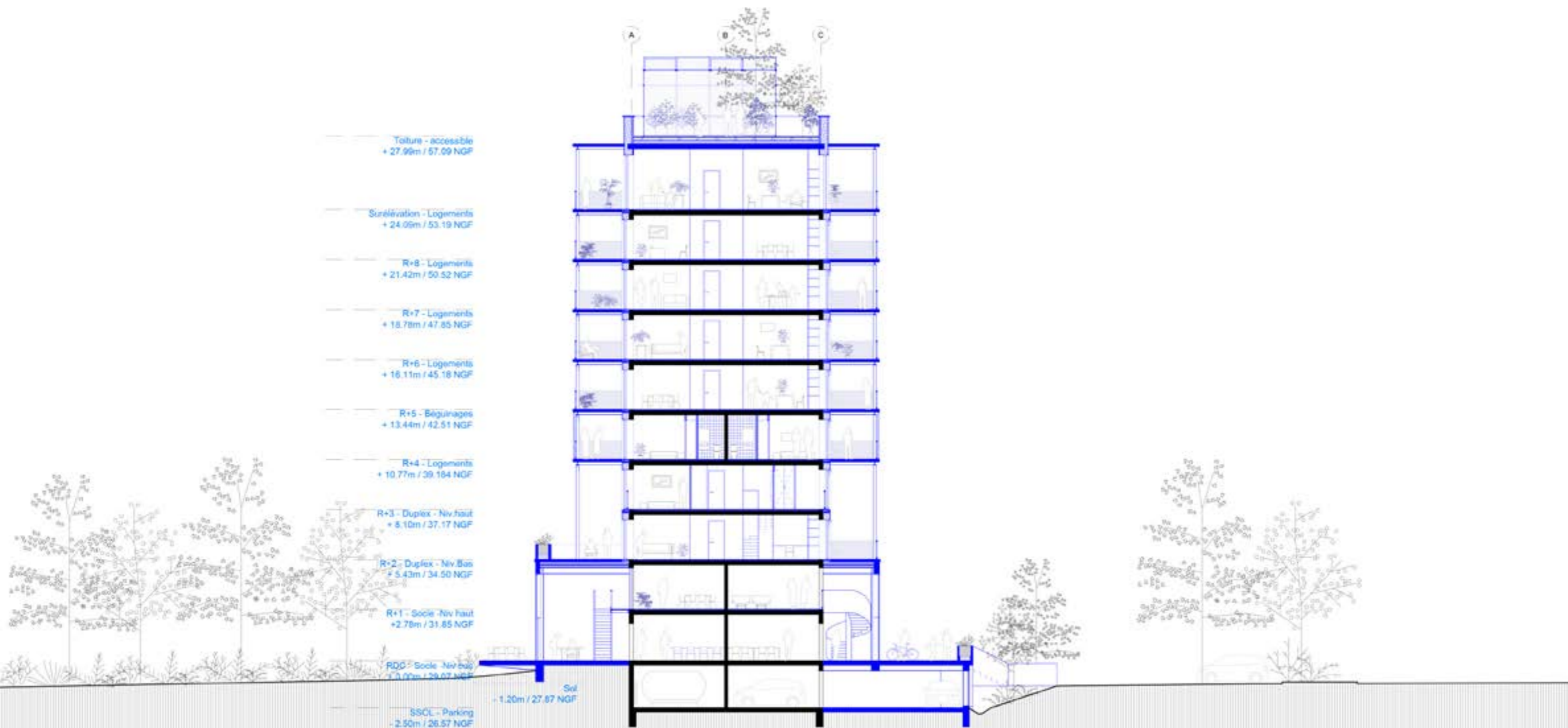

Coupe transversale

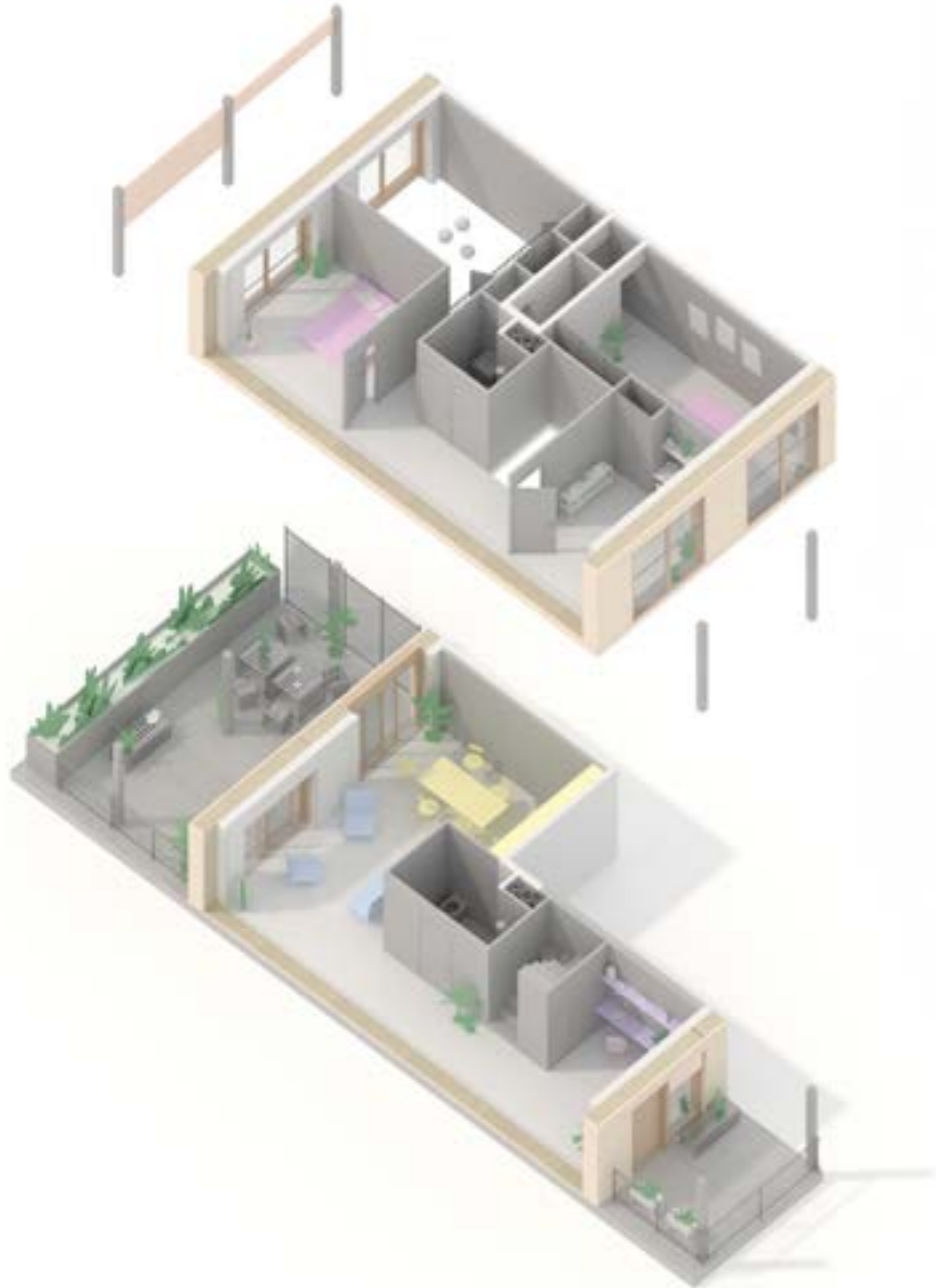
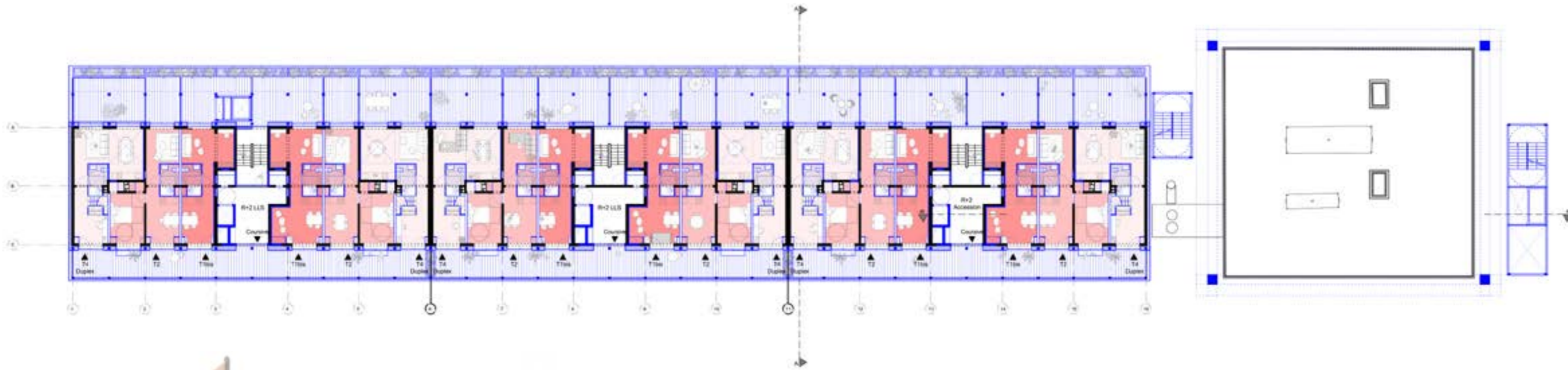

Plan R+2 - Duplex

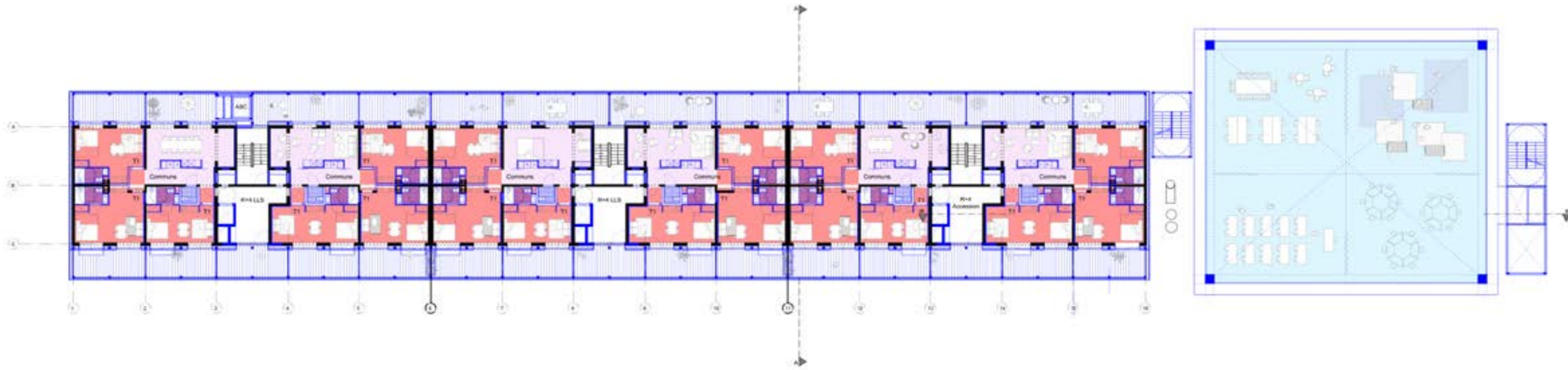

Plan R+4 - Les béguinages

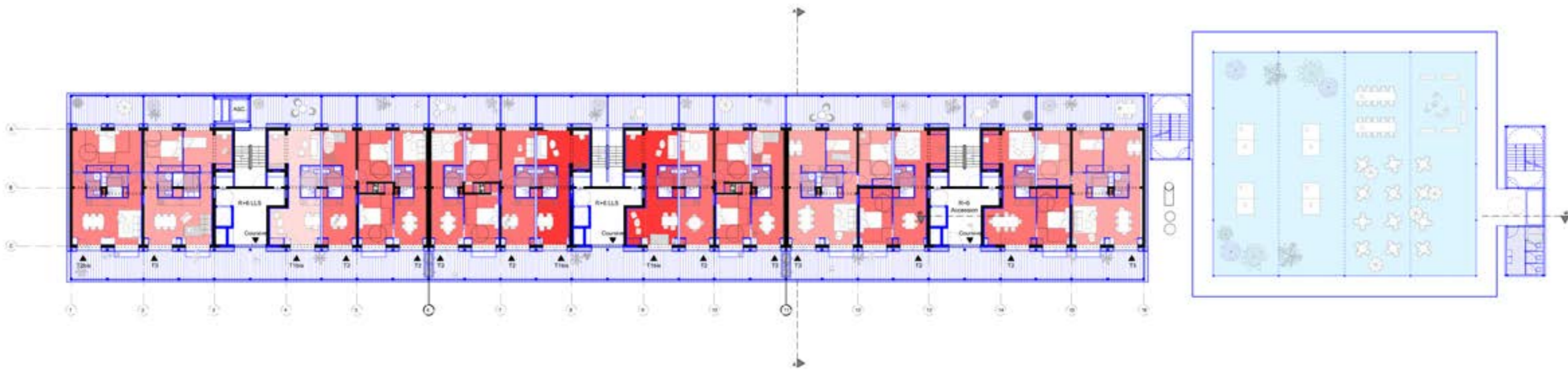

Plan étage courant

Espace de vie d'un logement





Balcons privés côté Ouest

Matériaux issus des filières locales

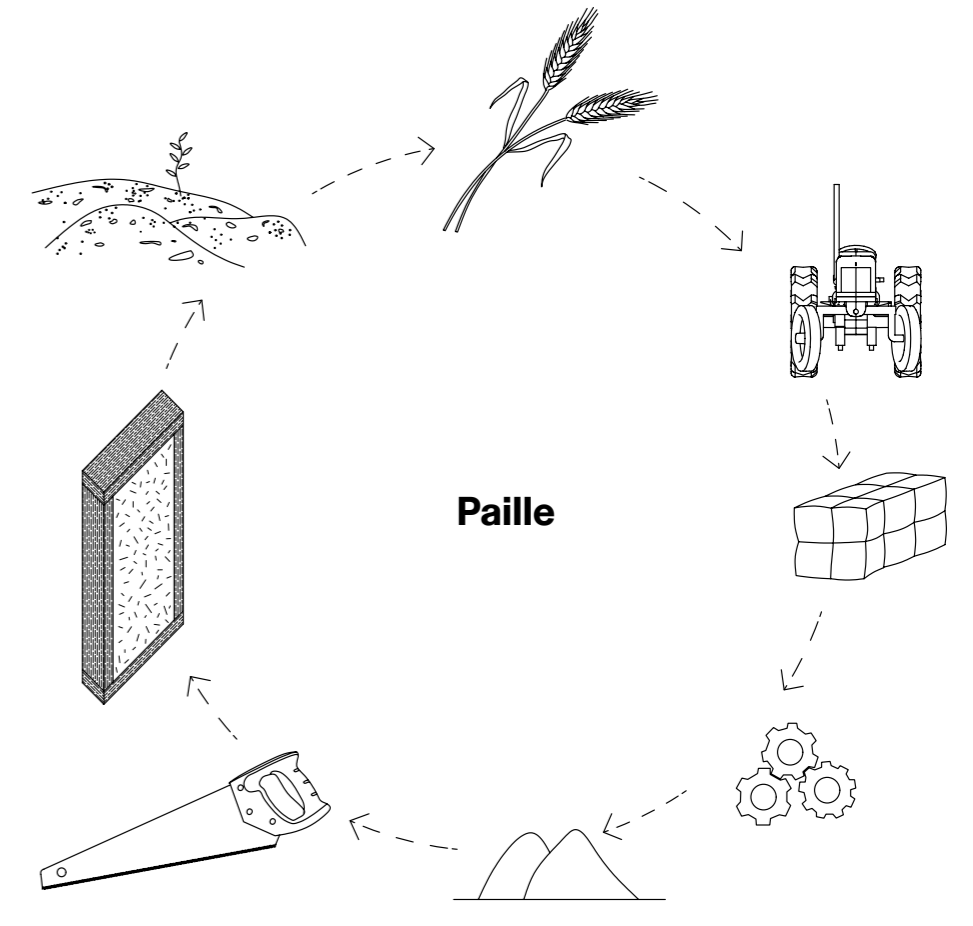
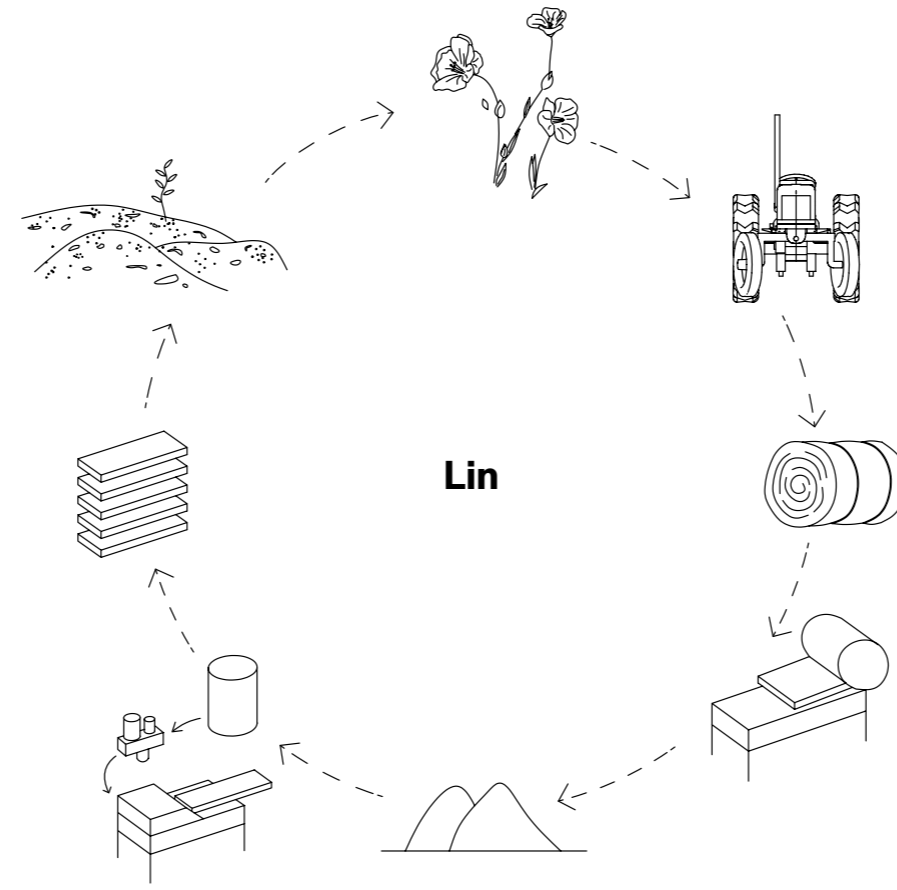
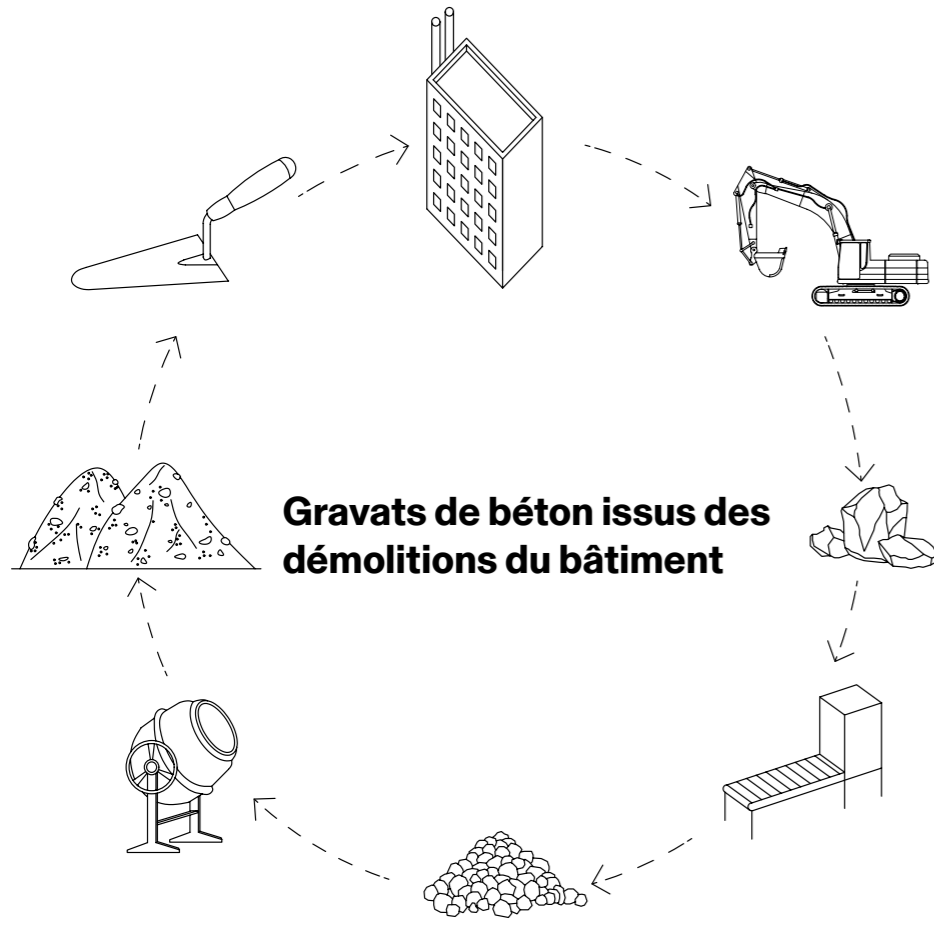



Schéma conservation de l'existant



**Blocs maçonnés en gravats
recyclés**

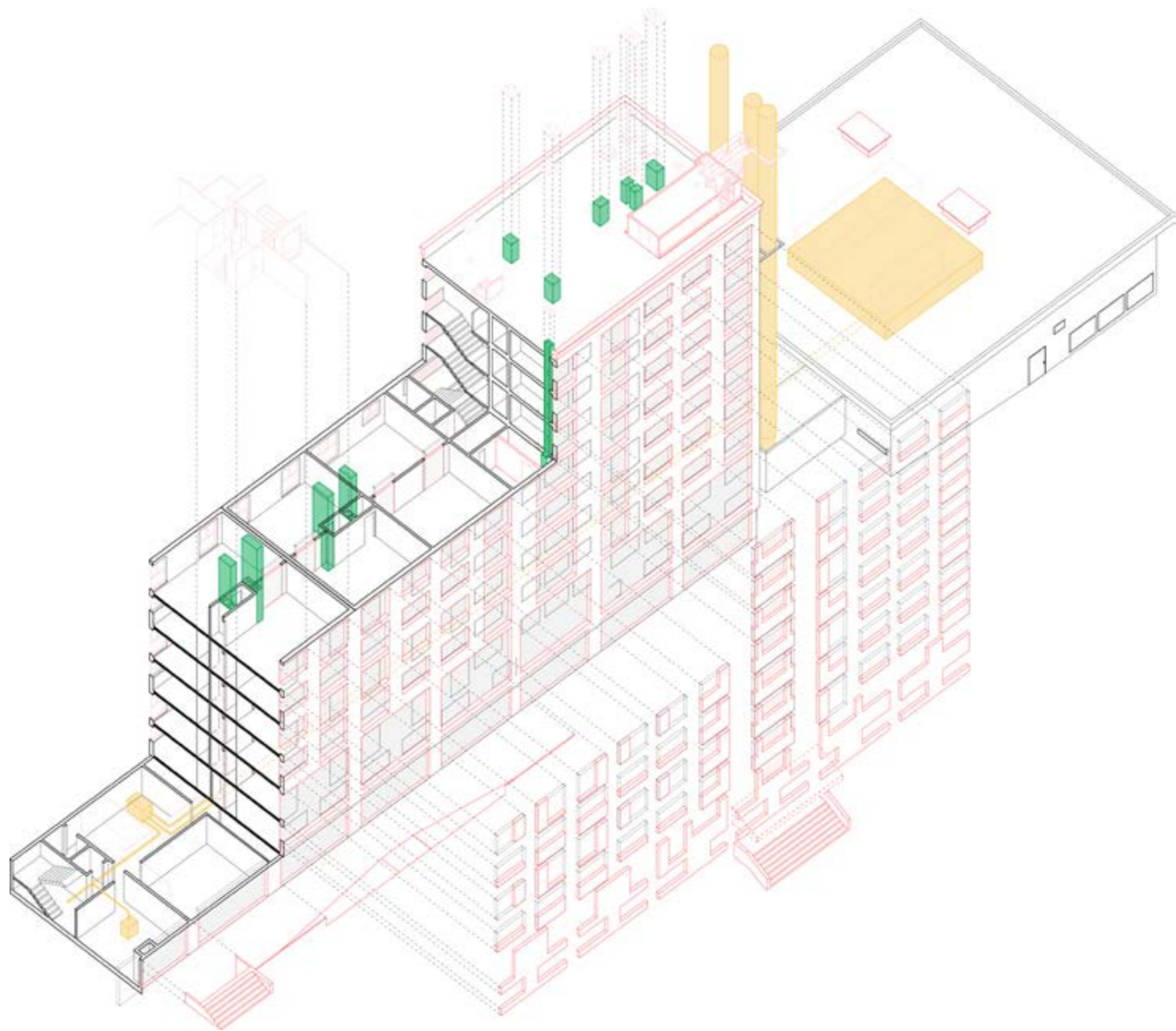

ITE caisson paille



Projet sans Placo

Un bâtiment sobre et bioclimatique

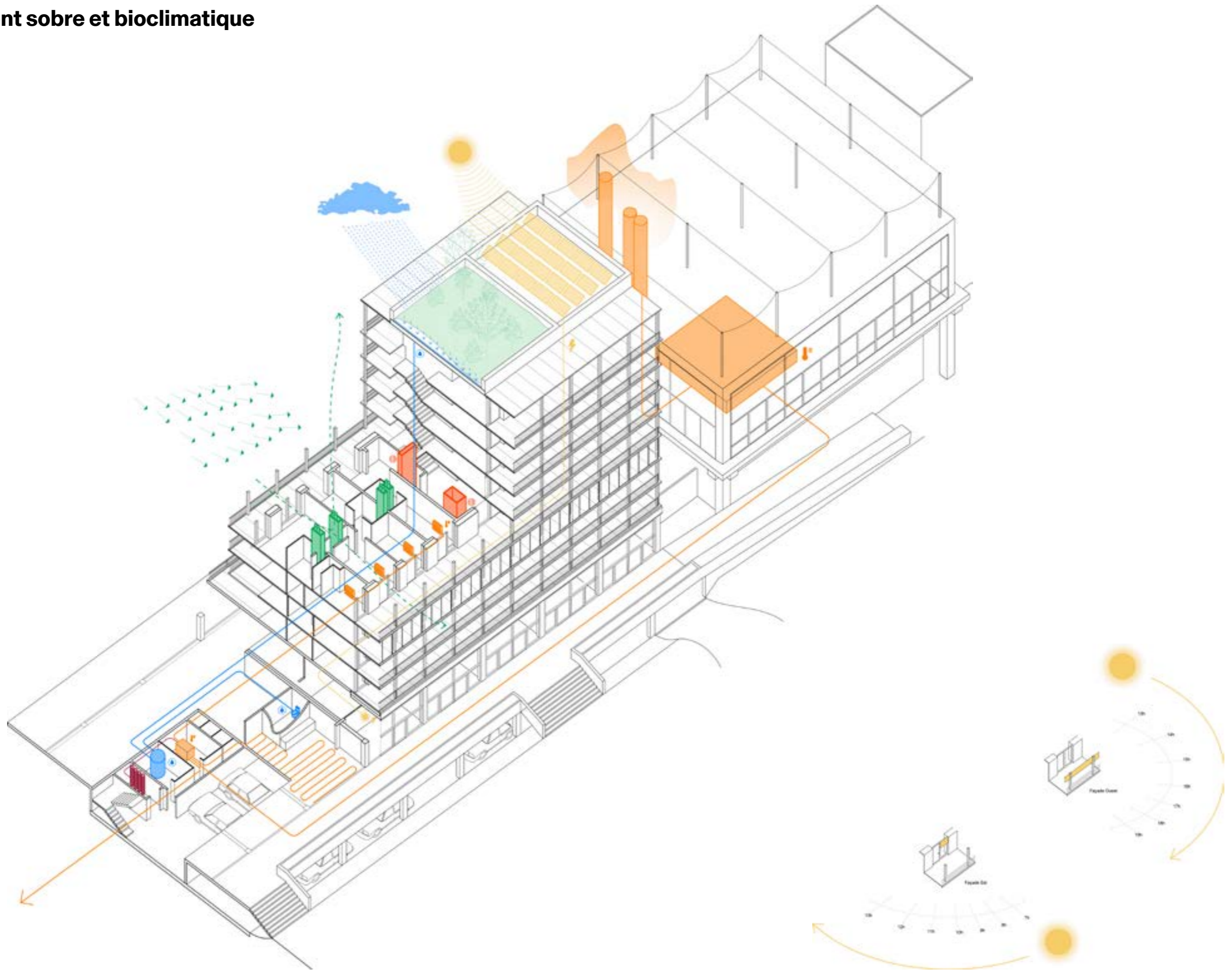

Merci!

